



Independant®

Medical Supply Units

Standard configurations of the Ceiling Supply
Units and Wall Supply Units



Table of content

	Page
Independant® Flex S	4
■ Two-arm system with vertical console (electropneumatic and electromagnetic braking system)	5
Independant® Flex M	6
■ Two-arm system with vertical console (electropneumatic braking system)	7
Independant® Flex M	8
■ Two-arm system with horizontal console (electromagnetic braking system)	9
Independant® Fix Bridge	10
■ Independant® Fix Bridge with trolley	11
■ Independant® Fix Bridge with trolley and console	12
Independant® Fix Ceiling	14
■ Independant® Fix Ceiling – vertical system	15
Independant® Care Horizontal	16
■ Independant® Care Horizontal ES - horizontally aligned	17
■ Independant® Care Horizontal MD - horizontally aligned	18
■ Independant® Care Horizontal LG - horizontally aligned	19
Independant® Care Vertical	20
■ Independant® Care Vertical ES - vertical aligned	21
■ Independant® Care Vertical MD - vertical aligned	22
■ Independant® Care Vertical LG - vertical aligned	23
Independant® Wall	24
■ Independant® Wall – vertical wall supply system	25



Independant® Flex S –

Tandem configuration of the Independant® Flex S, each with a vertical console and various accessories.

Independant® Flex S – Two-arm system with vertical console

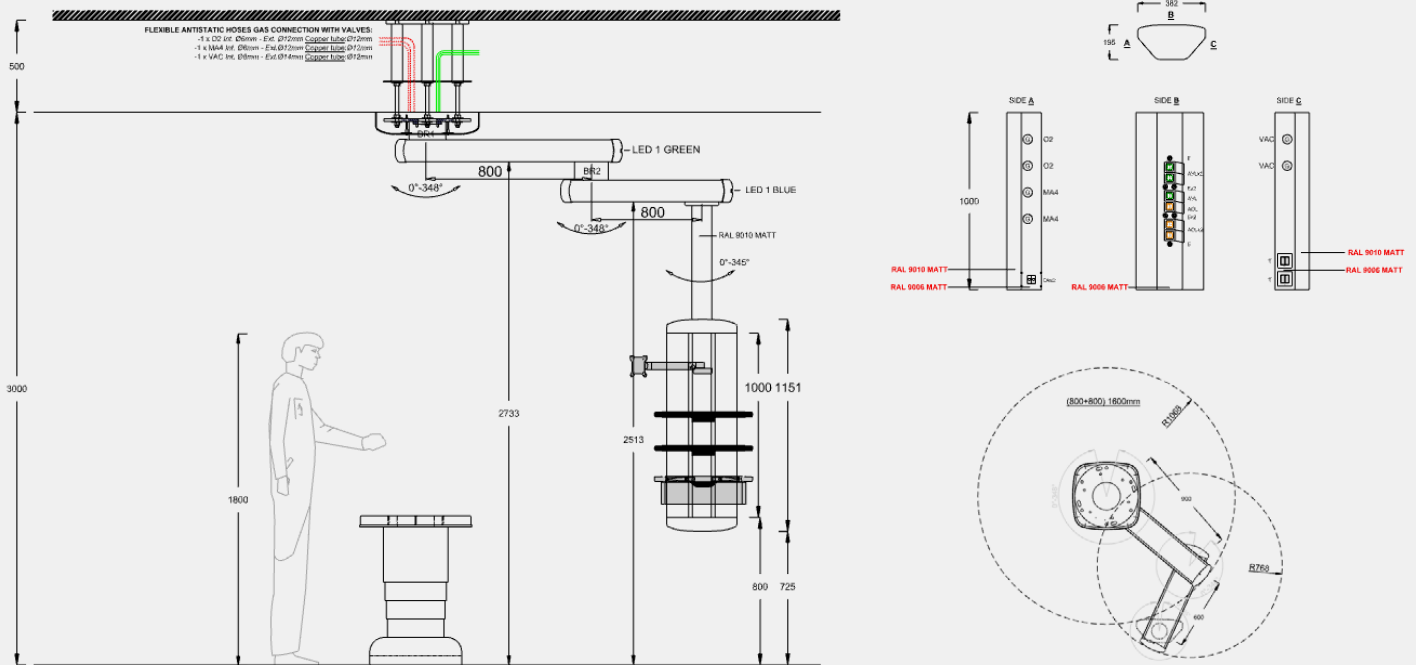

- Two-arm system 800 x 800 mm
- Vertical console 1000 mm
- Electropneumatic brake
- 2 x shelf L: 530 mm W: 440 mm
- 1 x drawer with DIN-rail L: 530 mm W: 450 mm H: 160 mm*
- One-arm monitor holder L = 300 mm

* The drawers always contain one shelf in each configuration.

Article number	Description	Electr. socket	Gas socket	Data socket
Configuration with electropneumatic brake				
85-110-01-04	Independant® Flex S EP (EU)	6 x Schuko (PEHA)	DIN (Greggerson) - 2 x O2, MA4, VAC	2 x RJ45; 2 x empty socket; 6 x Ep
85-110-02-04	Independant® Flex S EP (Asia)	6 x BS (Wandsworth)	BS (Behringer) - 2 x O2, MA4, VAC	2 x RJ45; 2 x empty socket; 6 x Ep
85-110-03-04	Independant® Flex S EP (America)	6 x US (Leviton)	DISS - NFPA (Amico) - 2 x O2, MA4, VAC	2 x RJ45; 2 x empty socket; 6 x Ep
85-110-04-04	Independant® Flex S EP (Africa)	6 x NF (MOSAIC)	AFNOR (MD) - 2 x O2, MA4, VAC	2 x RJ45; 2 x empty socket; 6 x Ep
Configuration with electromagnetic brake				
85-110-05-04	Independant® Flex S EM (EU)	6 x Schuko (PEHA)	DIN (Greggerson) - 2 x O2, MA4, VAC	2 x RJ45; 2 x empty socket; 6 x Ep
85-110-06-04	Independant® Flex S EM (Asia)	6 x BS (Wandsworth)	BS (Behringer) - 2 x O2, MA4, VAC	2 x RJ45; 2 x empty socket; 6 x Ep
85-110-07-04	Independant® Flex S EM (America)	6 x US (Leviton)	DISS - NFPA (Amico) - 2 x O2, MA4, VAC	2 x RJ45; 2 x empty socket; 6 x Ep
85-110-08-04	Independant® Flex S EM (Africa)	6 x NF (MOSAIC)	AFNOR (MD) - 2 x O2, MA4, VAC	2 x RJ45; 2 x empty socket; 6 x Ep



Independant® Flex M and Independant® Flex S

Two configurations with a motorized two-arm system with a horizontal console and a single-arm motorized system with a vertical console.

Independant® Flex M – Two-arm motorized system with vertical console

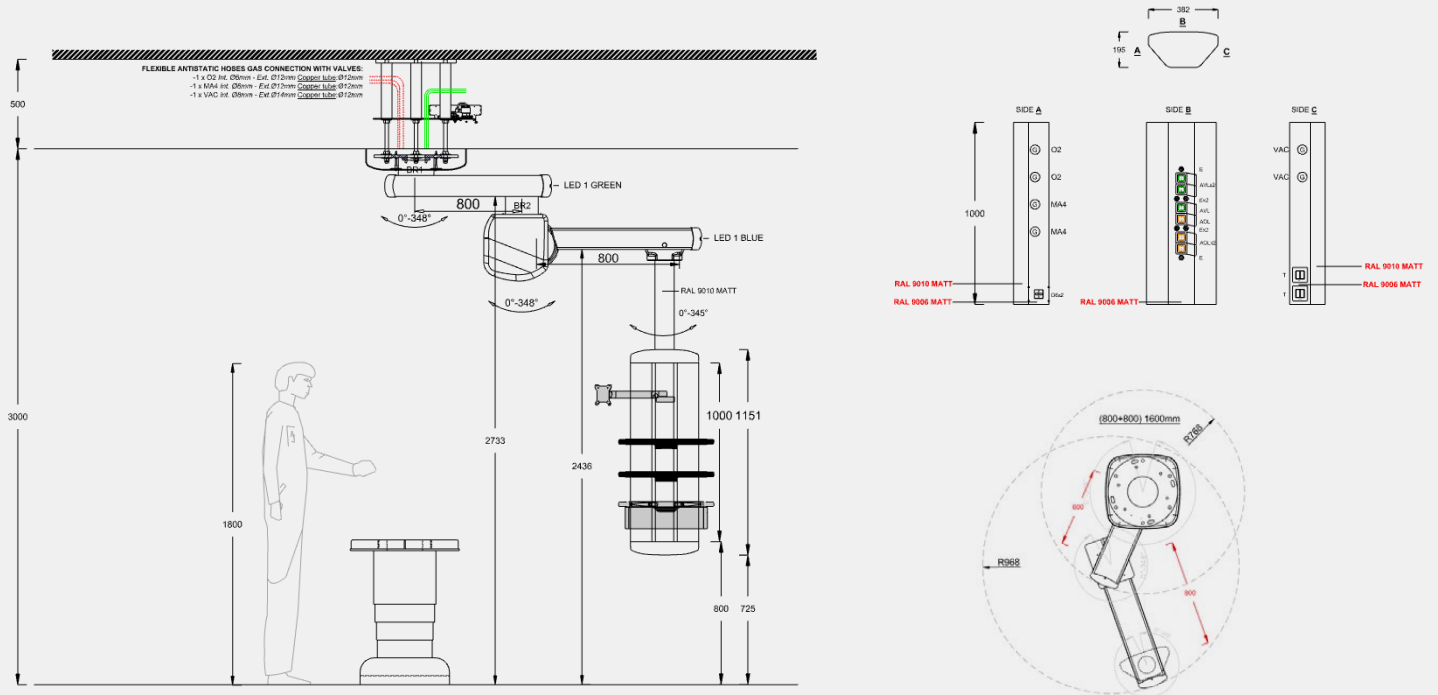

- Two-arm motorized system with vertical console 800 x 800 mm
- Vertical console 1000 mm
- Electropneumatic brake
- 2 x shelf L: 530 mm W: 440 mm
- 1 x drawer with DIN-rail L: 530 mm W: 450 mm H: 160 mm*
- One-arm monitor holder L = 300 mm

* The drawers always contain one shelf in each configuration.

Article number	Description	Electr. socket	Gas socket	Data socket
Configuration with electropneumatic brake & vertical console				
85-110-09-04	Independant® Flex M EP (EU)	6 x Schuko (PEHA)	DIN (Greggerson) - 2 x O2, MA4, VAC	2 x RJ45; 2 x empty socket; 6 x Ep
85-110-10-04	Independant® Flex M EP (Asia)	6 x BS (Wandsworth)	BS (Behringer) - 2 x O2, MA4, VAC	2 x RJ45; 2 x empty socket; 6 x Ep
85-110-11-04	Independant® Flex M EP (America)	6 x US (Leviton)	DISS - NFPA (Amico) - 2 x O2, MA4, VAC	2 x RJ45; 2 x empty socket; 6 x Ep
85-110-12-04	Independant® Flex M EP (Africa)	6 x NF (MOSAIC)	AFNOR (MD) - 2 x O2, MA4, VAC	2 x RJ45; 2 x empty socket; 6 x Ep



Independant® Flex M

Motorized configurations with a two-arm system with a horizontal console and a single-arm system with a vertical console.

Independant® Flex M – Two-arm motorized system with horizontal console

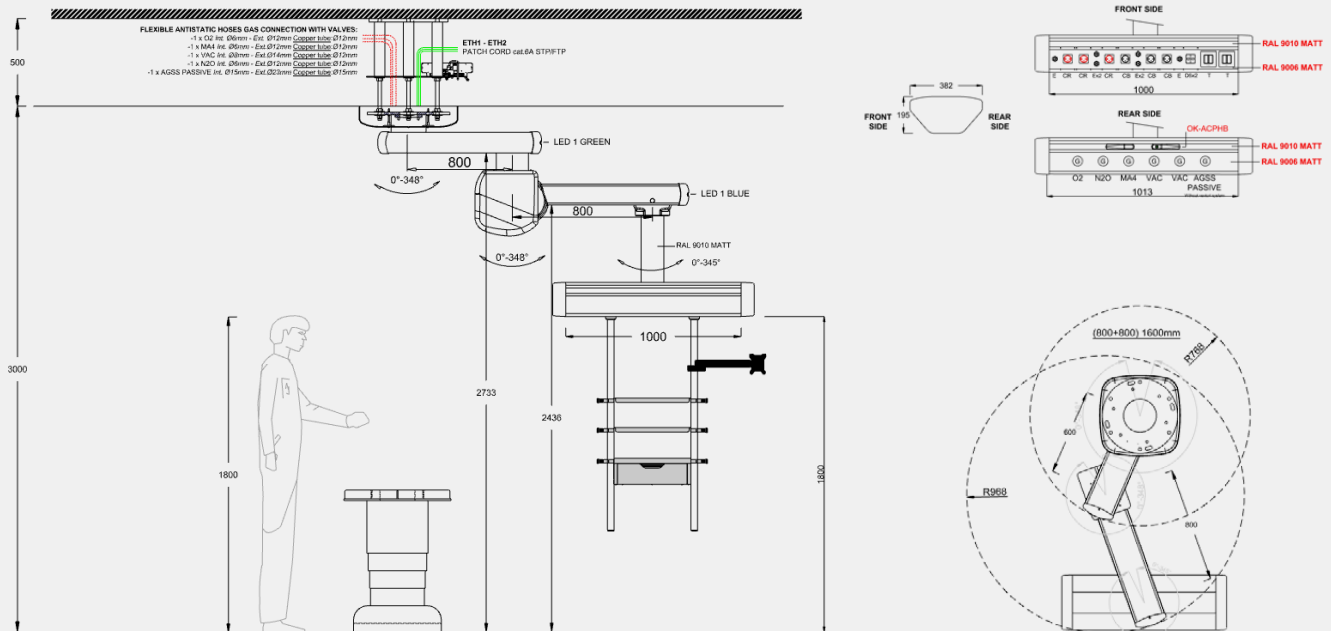

- Two-arm motorized system 800 x 800 mm
- Horizontal console 800 mm with trolley
- Electromagnetic brake
- 2 x shelf L: 530 mm W: 440 mm
- 1 x drawer with DIN-rail L: 530 mm W: 450 mm H: 160 mm*
- One-arm monitor holder L = 300 mm

* The drawers always contain one shelf in each configuration.

Article number	Description	Electr. socket	Gas socket	Data socket
Configuration with electromagnetic brake and horizontal console				
85-110-13-04	Independant® Flex M EM (EU)	6 x Schuko (PEHA)	DIN (Greggerson) - 2 x O2, MA4, VAC	2 x RJ45; 2 x empty socket; 6 x Ep
85-110-14-04	Independant® Flex M EM (Asia)	6 x BS (Wandsworth)	BS (Behringer) - 2 x O2, MA4, VAC	2 x RJ45; 2 x empty socket; 6 x Ep
85-110-15-04	Independant® Flex M EM (America)	6 x US (Leviton)	DISS - NFPA (Amico) - 2 x O2, MA4, VAC	2 x RJ45; 2 x empty socket; 6 x Ep
85-110-16-04	Independant® Flex M EM (Africa)	6 x NF (MOSAIC)	AFNOR (MD) - 2 x O2, MA4, VAC	2 x RJ45; 2 x empty socket; 6 x Ep



Independant® Fix Bridge

Ceiling supply unit with a sliding trolley and a vertical console.

Independant® Fix Bridge – Supply system with movable and rotatable trolley

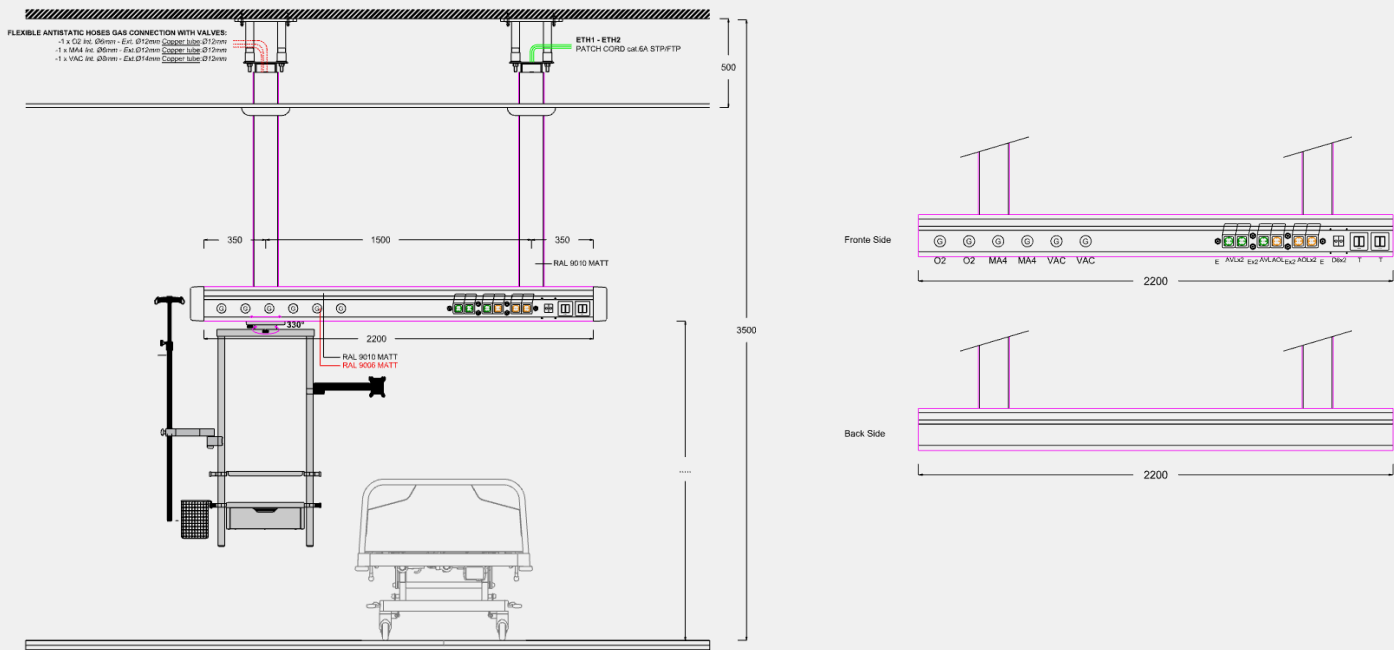

- Supply system 2200 mm
- Movable and rotatable trolley
- Basket for storing consumable materials

- 1 x Infusion pole with 4 hooks L = 1000 mm
- 1 x drawer with DIN-rail L: 530 mm W: 450 mm H: 160 mm*
- One-arm monitor holder L = 300 mm

* The drawers always contain one shelf in each configuration.

Article number	Description	Electr. socket	Gas socket	Data socket
85-110-20-04	Independant® Fix Bridge (EU)	6 x Schuko (PEHA)	DIN (Greggerson) - 2 x O2, MA4, VAC	2 x RJ45; 2 x empty socket; 6 x Ep
85-110-21-04	Independant® Fix Bridge (Asia)	6 x BS (Wandsworth)	BS (Behringer) - 2 x O2, MA4, VAC	2 x RJ45; 2 x empty socket; 6 x Ep
85-110-22-04	Independant® Fix Bridge (America)	6 x US (Leviton)	DISS - NFPA (Amico) - 2 x O2, MA4, VAC	2 x RJ45; 2 x empty socket; 6 x Ep
85-110-23-04	Independant® Fix Bridge (Africa)	6 x NF (MOSAIC)	AFNOR (MD) - 2 x O2, MA4, VAC	2 x RJ45; 2 x empty socket; 6 x Ep

Independant® Fix Bridge – Supply system with trolley and vertical console

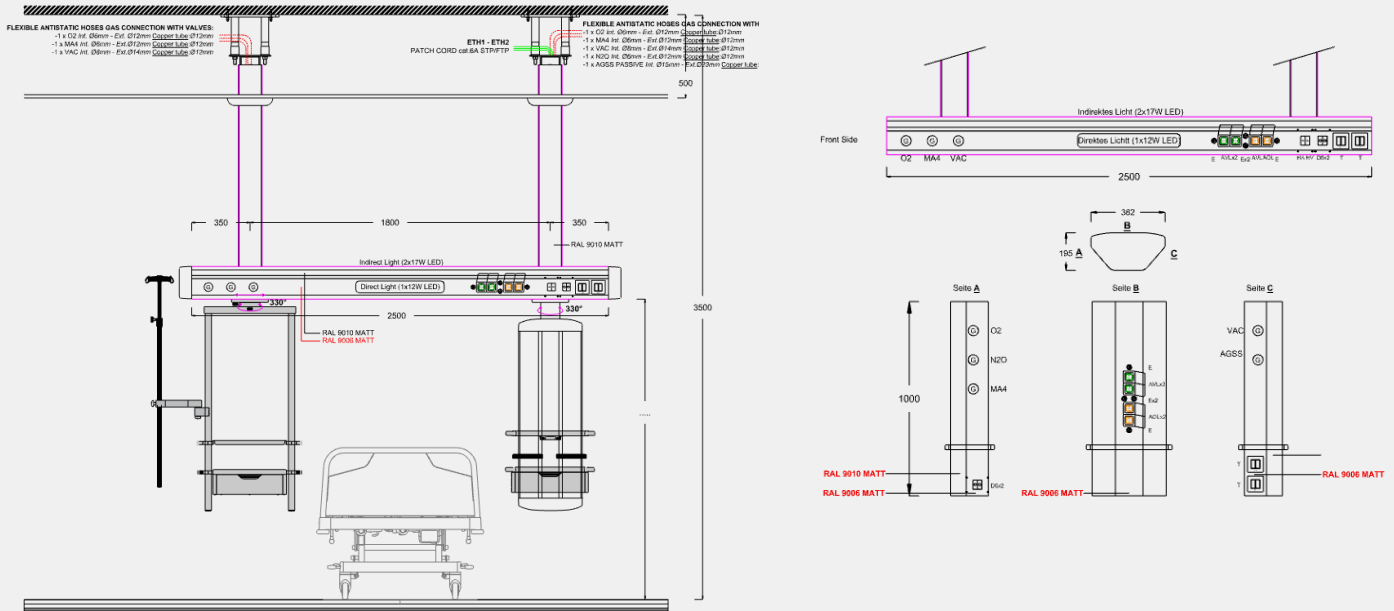

- Supply system 2500 mm
- Movable and rotatable trolley
- Rotatable vertical console

- 1 x shelf L: 530 mm W: 440 mm
- 1 x drawer with DIN-rail L: 530 mm W: 450 mm H: 160 mm*
- One-arm monitor holder L = 300 mm

* The drawers always contain one shelf in each configuration.

Article number	Description	Electr. socket	Gas socket	Data socket
85-110-24-04	Independant® Fix Bridge + console (EU)	6 x Schuko (PEHA)	DIN (Greggerson) - 2 x O2, MA4, VAC	2 x RJ45; 2 x empty socket; 6 x Ep
85-110-25-04	Independant® Fix Bridge + console (Asia)	6 x BS (Wandsworth)	BS (Behringer) - 2 x O2, MA4, VAC	2 x RJ45; 2 x empty socket; 6 x Ep
85-110-26-04	Independant® Fix Bridge + console (America)	6 x US (Leviton)	DISS - NFPA (Amico) - 2 x O2, MA4, VAC	2 x RJ45; 2 x empty socket; 6 x Ep
85-110-27-04	Independant® Fix Bridge + console (Africa)	6 x NF (MOSAIC)	AFNOR (MD) - 2 x O2, MA4, VAC	2 x RJ45; 2 x empty socket; 6 x Ep





Independant® Fix Ceiling –

Fixed ceiling supply unit with a vertical rotatable console.

Independant® Fix Ceiling – Vertical ceiling supply unit

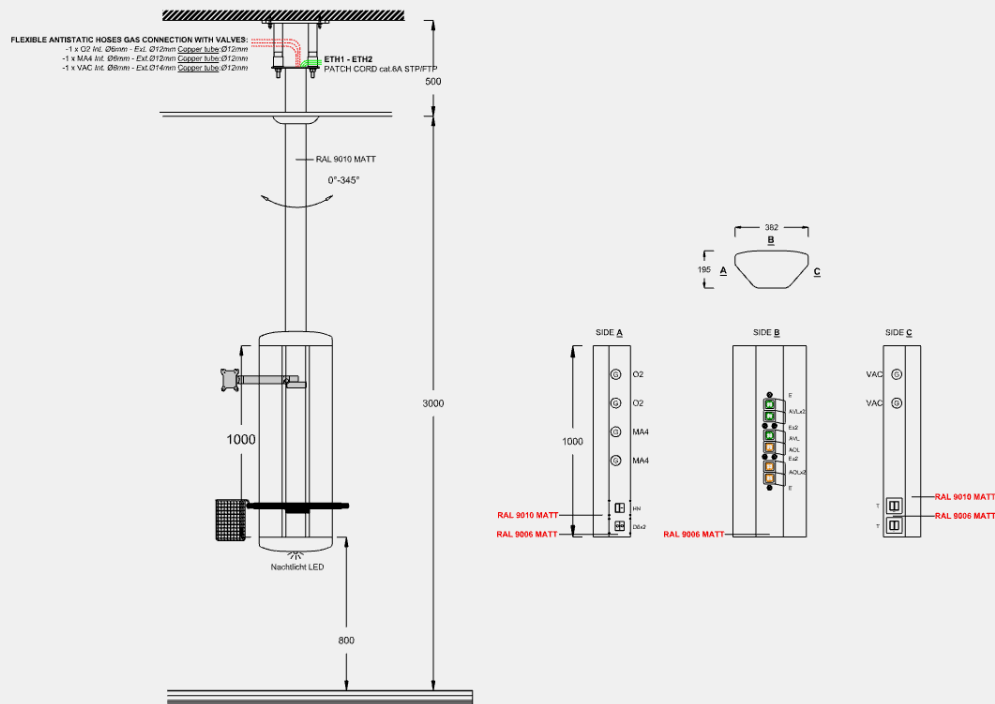

- Vertical supply unit 1000 mm
- Rotatable console by 345°
- 1 x basket for storing consumable materials
- 1 x shelf L: 530 mm W: 440 mm

Article number	Description	Electr. socket	Gas socket	Data socket
85-110-30-04	Independant® Fix Ceiling (EU)	6 x Schuko (PEHA)	DIN (Greggerson) - 2 x O2, MA4, VAC	2 x RJ45; 2 x empty socket; 6 x Ep
85-110-31-04	Independant® Fix Ceiling (Asia)	6 x BS (Wandsworth)	BS (Behringer) - 2 x O2, MA4, VAC	2 x RJ45; 2 x empty socket; 6 x Ep
85-110-32-04	Independant® Fix Ceiling (America)	6 x US (Leviton)	DISS - NFPA (Amico) - 2 x O2, MA4, VAC	2 x RJ45; 2 x empty socket; 6 x Ep
85-110-33-04	Independant® Fix Ceiling (Africa)	6 x NF (MOSAIC)	AFNOR (MD) - 2 x O2, MA4, VAC	2 x RJ45; 2 x empty socket; 6 x Ep



Independant® Care Horizontal

Two horizontally aligned wall-mounted supply units with two standard rails for adapting accessories as well as indirect and direct light.

Independant® Care Horizontal ES – Horizontally aligned wall supply system

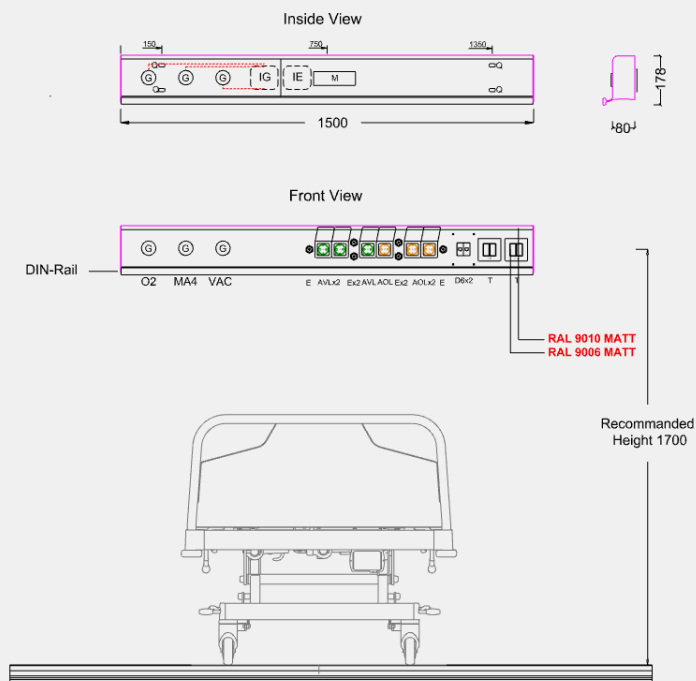

- Horizontal supply system L = 1500 mm
- One-profile system
- Standard rail bottom with 50 kg/m load capacity

Article number	Description	Electr. socket	Gas socket	Data socket
85-110-40-04	Independant® Care Horizontal ES (EU)	6 x Schuko (PEHA)	DIN (Greggerson) - 2 x O2, MA4, VAC	2 x RJ45; 2 x empty socket; 6 x Ep
85-110-41-04	Independant® Care Horizontal ES (Asia)	6 x BS (Wandsworth)	BS (Behringer) - 2 x O2, MA4, VAC	2 x RJ45; 2 x empty socket; 6 x Ep
85-110-42-04	Independant® Care Horizontal ES (America)	6 x US (Leviton)	DISS - NFPA (Amico) - 2 x O2, MA4, VAC	2 x RJ45; 2 x empty socket; 6 x Ep
85-110-43-04	Independant® Care Horizontal ES (Africa)	6 x NF (MOSAIC)	AFNOR (MD) - 2 x O2, MA4, VAC	2 x RJ45; 2 x empty socket; 6 x Ep

Independant® Care Horizontal MD – Horizontally aligned wall supply system

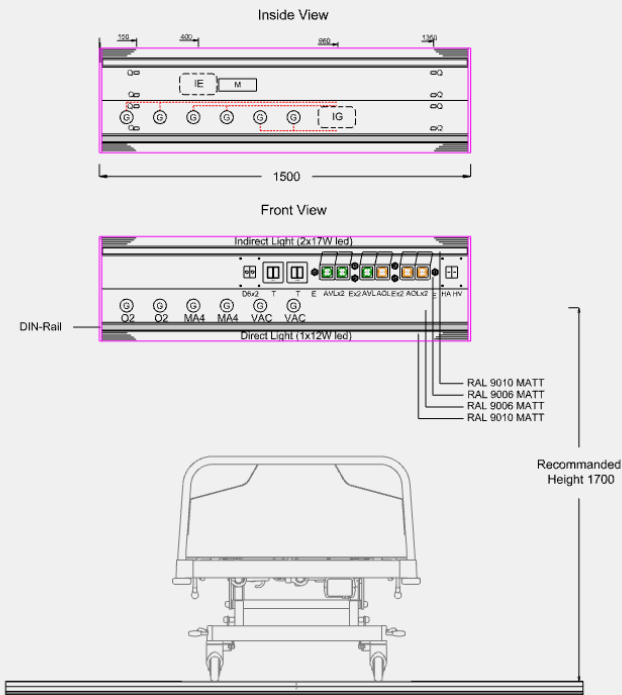

- Horizontal supply system L = 1500 mm
- Double-profile system
- DIN-rail bottom and top

- Separation of gas and electrics due to two-profile system
- Direct and indirect light

Article number	Description	Electr. socket	Gas socket	Data socket
85-110-44-04	Independant® Care Horizontal MD (EU)	6 x Schuko (PEHA)	DIN (Greggerson) - 2 x O2, MA4, VAC	2 x RJ45; 2 x empty socket; 6 x Ep
85-110-45-04	Independant® Care Horizontal MD (Asia)	6 x BS (Wandsworth)	BS (Behringer) - 2 x O2, MA4, VAC	2 x RJ45; 2 x empty socket; 6 x Ep
85-110-46-04	Independant® Care Horizontal MD (America)	6 x US (Leviton)	DISS - NFPA (Amico) - 2 x O2, MA4, VAC	2 x RJ45; 2 x empty socket; 6 x Ep
85-110-47-04	Independant® Care Horizontal MD (Africa)	6 x NF (MOSAIC)	AFNOR (MD) - 2 x O2, MA4, VAC	2 x RJ45; 2 x empty socket; 6 x Ep

Independant® Care Horizontal LG – Horizontally aligned wall supply system

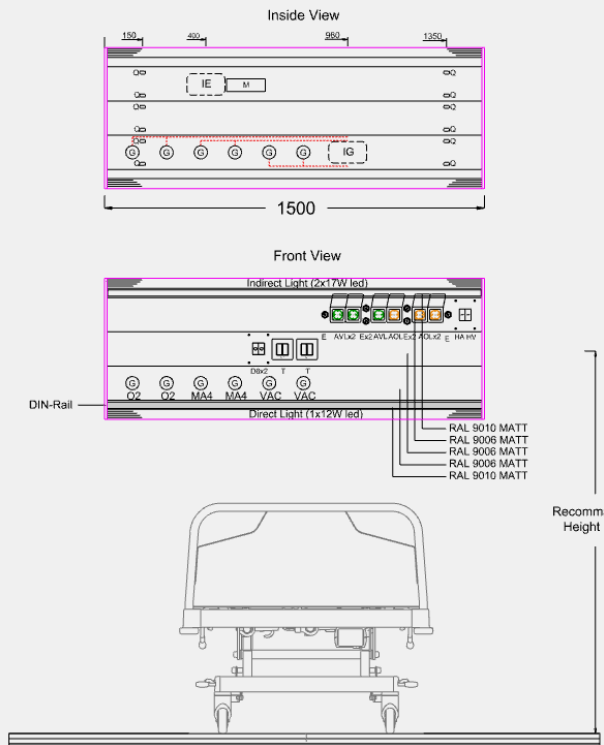

- Horizontal supply system L = 1500 mm
- Triple-profile system
- DIN-rail bottom and top

- Separation of gas and electrics due to triple-profile system
- Direct and indirect light

Article number	Description	Electr. socket	Gas socket	Data socket
85-110-48-04	Independant® Care Horizontal LG (EU)	6 x Schuko (PEHA)	DIN (Greggerson) - 2 x O2, MA4, VAC	2 x RJ45; 2 x empty socket; 6 x Ep
85-110-49-04	Independant® Care Horizontal LG (Asia)	6 x BS (Wandsworth)	BS (Behringer) - 2 x O2, MA4, VAC	2 x RJ45; 2 x empty socket; 6 x Ep
85-110-50-04	Independant® Care Horizontal LG (America)	6 x US (Leviton)	DISS - NFPA (Amico) - 2 x O2, MA4, VAC	2 x RJ45; 2 x empty socket; 6 x Ep
85-110-51-04	Independant® Care Horizontal LG (Africa)	6 x NF (MOSAIC)	AFNOR (MD) - 2 x O2, MA4, VAC	2 x RJ45; 2 x empty socket; 6 x Ep



Independant® Care Vertical

Two vertically aligned wall-mounted supply units with multifunctional rod for adapting accessories as well as indirect and direct light.

Independant® Care Vertical ES – Vertically aligned wall supply system

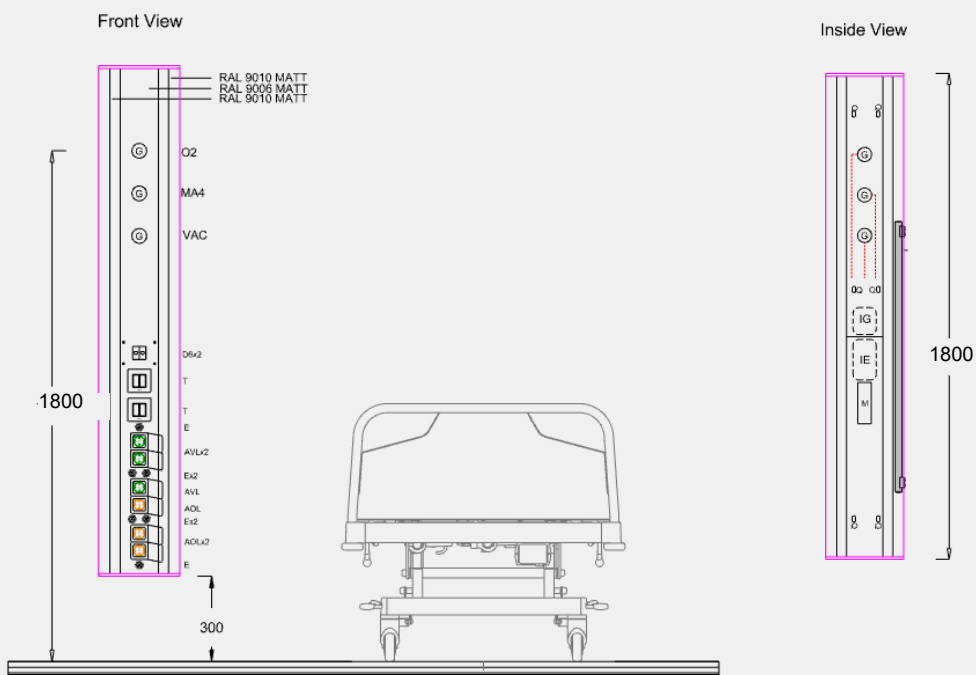

- Vertical supply system L = 1800 mm
- One-profile system
- Multifunctional rod right side

Article number	Description	Electr. socket	Gas socket	Data socket
85-110-52-04	Independant® Care Vertical ES (EU)	6 x Schuko (PEHA)	DIN (Greggerson) - 2 x O2, MA4, VAC	2 x RJ45; 2 x empty socket; 6 x Ep
85-110-53-04	Independant® Care Vertical ES (Asia)	6 x BS (Wandsworth)	BS (Behringer) - 2 x O2, MA4, VAC	2 x RJ45; 2 x empty socket; 6 x Ep
85-110-54-04	Independant® Care Vertical ES (America)	6 x US (Leviton)	DISS - NFPA (Amico) - 2 x O2, MA4, VAC	2 x RJ45; 2 x empty socket; 6 x Ep
85-110-55-04	Independant® Care Vertical ES (Africa)	6 x NF (MOSAIC)	AFNOR (MD) - 2 x O2, MA4, VAC	2 x RJ45; 2 x empty socket; 6 x Ep

Independant® Care Vertical MD – Vertically aligned wall supply system

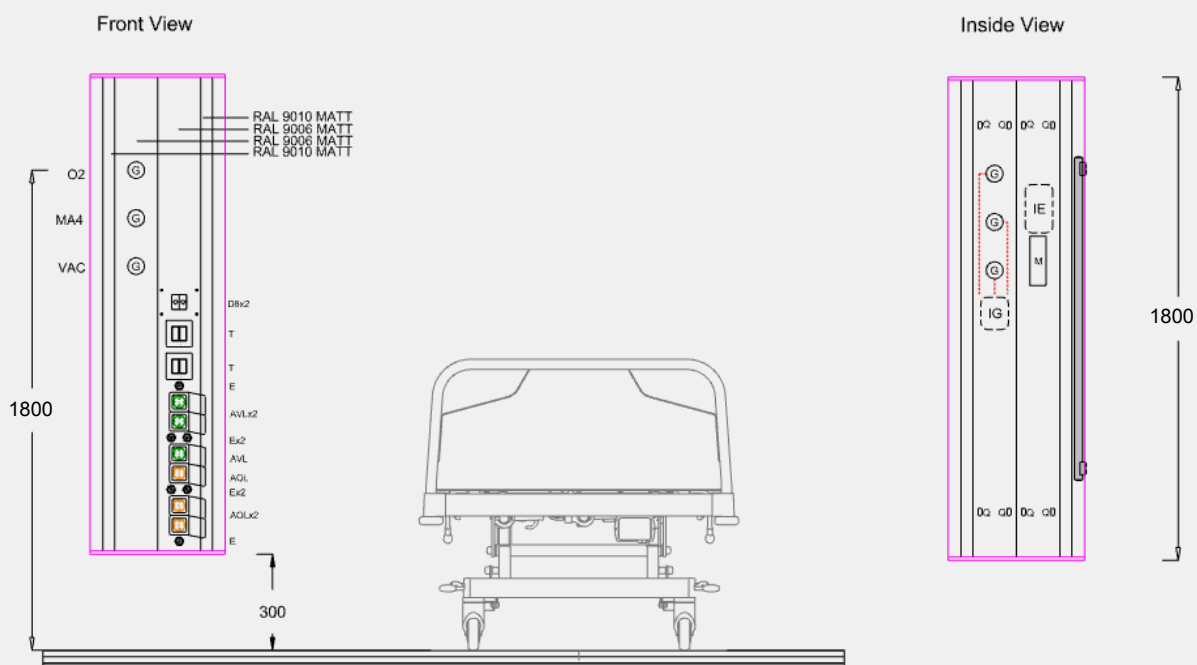

- Vertical supply system L = 1800 mm
- Double-profile system
- Multifunctional rod right side
- Separation of gas and electrics due to two-profile system

Article number	Description	Electr. socket	Gas socket	Data socket
85-110-56-04	Independant® Care Vertical MD (EU)	6 x Schuko (PEHA)	DIN (Greggerson) - 2 x O2, MA4, VAC	2 x RJ45; 2 x empty socket; 6 x Ep
85-110-57-04	Independant® Care Vertical MD (Asia)	6 x BS (Wandsworth)	BS (Behringer) - 2 x O2, MA4, VAC	2 x RJ45; 2 x empty socket; 6 x Ep
85-110-58-04	Independant® Care Vertical MD (America)	6 x US (Leviton)	DISS - NFPA (Amico) - 2 x O2, MA4, VAC	2 x RJ45; 2 x empty socket; 6 x Ep
85-110-59-04	Independant® Care Vertical MD (Africa)	6 x NF (MOSAIC)	AFNOR (MD) - 2 x O2, MA4, VAC	2 x RJ45; 2 x empty socket; 6 x Ep

Independant® Care Vertical LG – Vertically aligned wall supply system

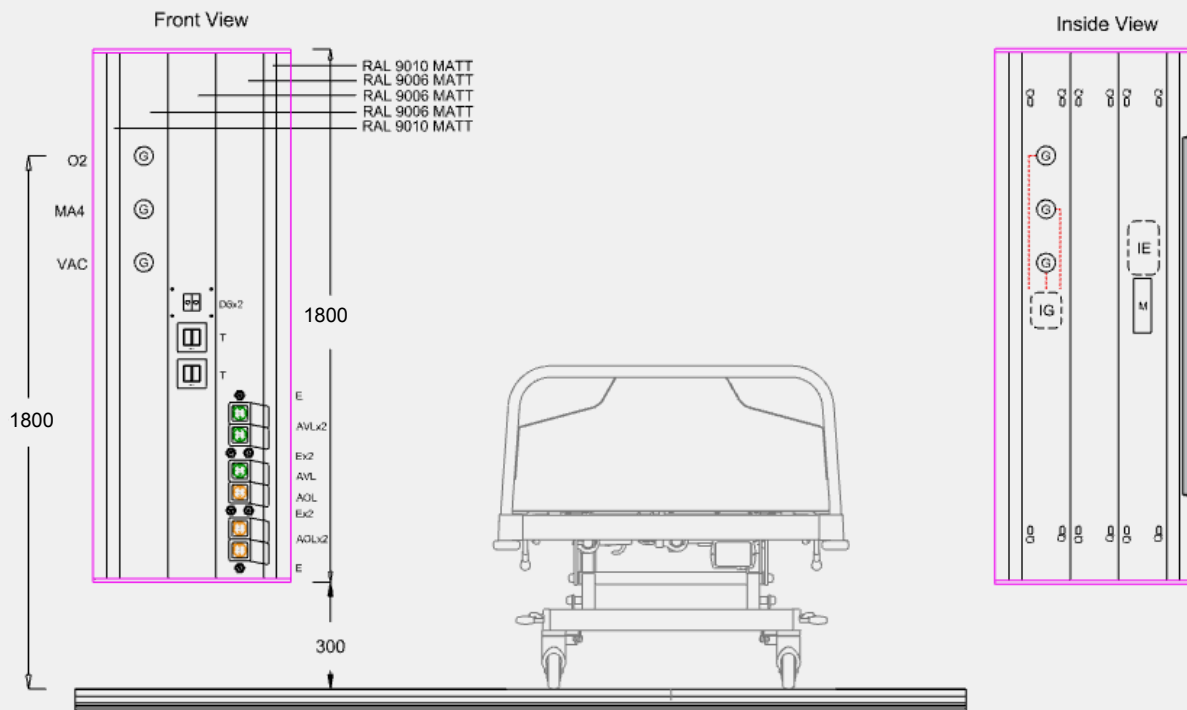

- Vertical supply system L = 1800 mm
- Triple-profile system
- Multifunctional rod right side
- Separation of gas and electrics due to triple-profile system

Article number	Description	Electr. socket	Gas socket	Data socket
85-110-60-04	Independant® Care Vertical LG (EU)	6 x Schuko (PEHA)	DIN (Greggerson) - 2 x O2, MA4, VAC	2 x RJ45; 2 x empty socket; 6 x Ep
85-110-61-04	Independant® Care Vertical LG (Asia)	6 x BS (Wandsworth)	BS (Behringer) - 2 x O2, MA4, VAC	2 x RJ45; 2 x empty socket; 6 x Ep
85-110-62-04	Independant® Care Vertical LG (America)	6 x US (Leviton)	DISS - NFPA (Amico) - 2 x O2, MA4, VAC	2 x RJ45; 2 x empty socket; 6 x Ep
85-110-63-04	Independant® Care Vertical LG (Africa)	6 x NF (MOSAIC)	AFNOR (MD) - 2 x O2, MA4, VAC	2 x RJ45; 2 x empty socket; 6 x Ep



Independant® Fix Wall –

Robust wall mounted supply unit with a central multifunctional rod for holding various accessories and indirect light.

Independant® Fix Wall – Vertical wall supply system with central multifunctional rod

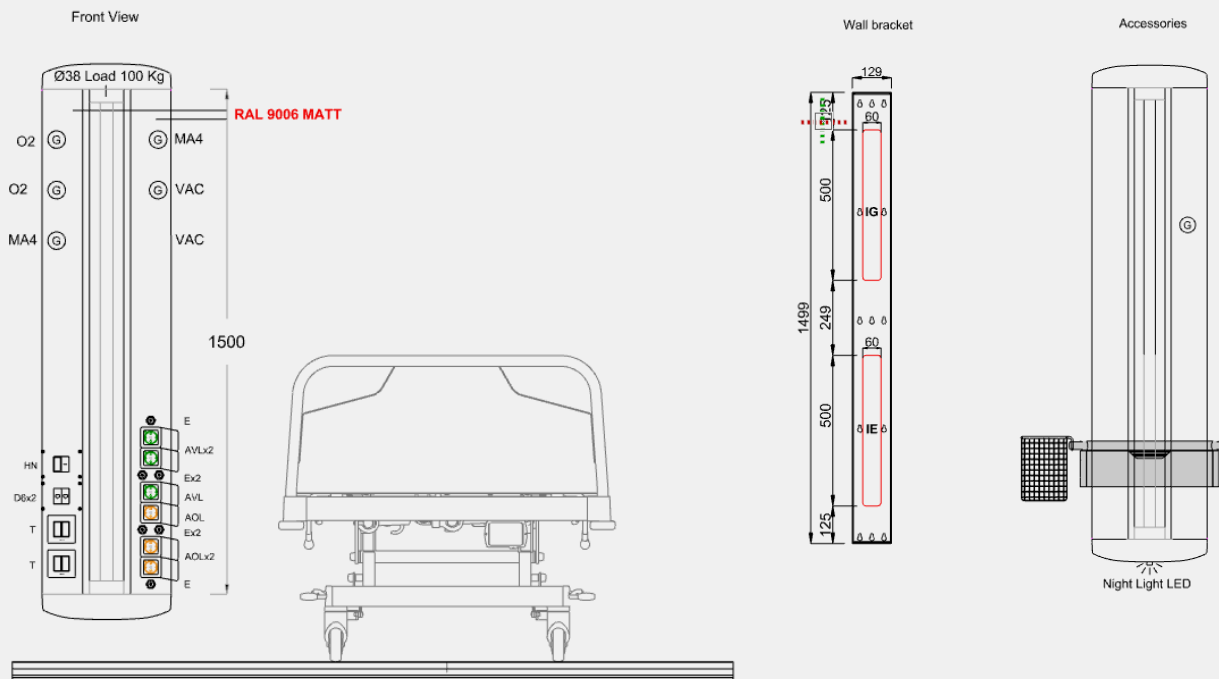

- Vertical supply system 1500 mm
- Central positioned multifunctional rod
- Load capacity 100 kg

- 1 x basket for storing consumable materials
- 1 x drawer with DIN-rail L: 530 mm W: 450 mm H: 160 mm*

* The drawers always contain one shelf in each configuration.

Article number	Description	Electr. socket	Gas socket	Data socket
85-110-64-04	Independant® Fix Wall (EU)	6 x Schuko (PEHA)	DIN (Greggerson) - 2 x O2, MA4, VAC	2 x RJ45; 2 x empty socket; 6 x Ep
85-110-65-04	Independant® Fix Wall (Asia)	6 x BS (Wandsworth)	BS (Behringer) - 2 x O2, MA4, VAC	2 x RJ45; 2 x empty socket; 6 x Ep
85-110-66-04	Independant® Fix Wall (America)	6 x US (Leviton)	DISS - NFPA (Amico) - 2 x O2, MA4, VAC	2 x RJ45; 2 x empty socket; 6 x Ep
85-110-67-04	Independant® Fix Wall (Africa)	6 x NF (MOSAIC)	AFNOR (MD) - 2 x O2, MA4, VAC	2 x RJ45; 2 x empty socket; 6 x Ep

KLS Martin Group

KLS Martin Australia Pty Ltd.

Sydney · Australia
Tel. +61 2 9439 5316
australia@klsmartin.com

KLS Martin do Brasil Ltda.

São Paulo · Brazil
Tel. +55 11 3554 2299
brazil@klsmartin.com

KLS Martin Medical (Shanghai) International Trading Co., Ltd

Shanghai · China
Tel. +86 21 5820 6251
info@klsmartin.com

KLS Martin India Pvt Ltd.

Chennai · India
Tel. +91 44 66 442 300
india@klsmartin.com

KLS Martin Italia S.r.l.

Milan · Italy
Tel. +39 039 605 67 31
info@klsmartin.com

KLS Martin Japan K.K.

Tokyo · Japan
Tel. +81 3 3814 1431
info@klsmartin.com

KLS Martin SE Asia Sdn. Bhd.

Penang · Malaysia
Tel. +604 261 7060
malaysia@klsmartin.com

KLS Martin de México, S.A. de C.V.

Mexico City · Mexico
Tel. +52 55 7572 0944
mexico@klsmartin.com

KLS Martin Nederland B.V.

Huizen · Netherlands
Tel. +31 35 523 45 38
infoln@klsmartin.com

KLS Martin SE & Co. KG

Moscow · Russia
Tel. +7 499 792 76 19
russia@klsmartin.com

KLS Martin Taiwan Ltd.

Taipei · Taiwan
Tel. +886 2 2325 3169
taiwan@klsmartin.com

KLS Martin SE & Co. KG

Dubai · United Arab Emirates
Tel. +971 4 454 16 55
middleeast@klsmartin.com

KLS Martin UK Ltd.

Reading · United Kingdom
Tel. +44 118 467 1500
info.uk@klsmartin.com

KLS Martin LP

Jacksonville · Florida, USA
Tel. +1 904 641 77 46
usa@klsmartin.com

KLS Martin SE Asia Sdn. Bhd.

Hanoi · Vietnam
Tel. +49 7461 706-0
info@klsmartin.com

KLS Martin SE & Co. KG

A company of the KLS Martin Group

KLS Martin Platz 1 · 78532 Tuttlingen · Germany
PO Box 60 · 78501 Tuttlingen · Germany
Tel. +49 7461 706-0 · Fax +49 7461 706-193
info@klsmartin.com · www.klsmartin.com